

<b>BUGAL</b> <small>Z.I. La Croix Rouge - 44260 MALVILLE          Tel: 02 40 57 00 41 Fax: 02 40 57 06 75</small>	DOSSIER	Profils	INDICE	E	 Profils PAGE 1/6 Ce plan est la propriété exclusive de la Sté BUGAL, et ne peut être communiqué à un tiers sans notre autorisation.
	PIECE/PROFIL		DATE	20/06/2016	
	DESIGNATION		ECHELLE	1/1	
	MATIERE	ALUMINIUM	PROJETEUR	S. PEDRONO	

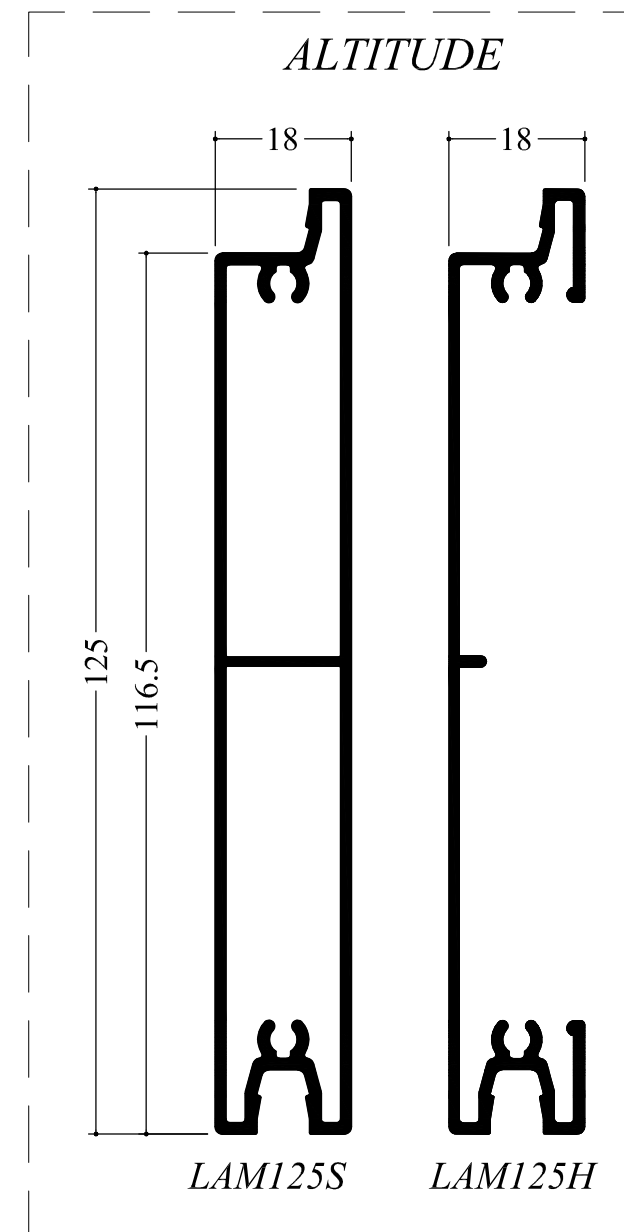

<p>Z.I. La Croix Rouge - 44260 MALVILLE Tel: 02 40 57 00 41 Fax: 02 40 57 06 75</p>	DOSSIER	Profils	INDICE	E	<p>Profils PAGE 2/6</p>
	PIECE/PROFIL		DATE	20/06/2016	
	DESIGNATION		ECHELLE	1/1	
	MATIERE	ALUMINIUM	PROJETEUR	S. PEDRONO	
	<p>Ce plan est la propriété exclusive de la Sté BUGAL, et ne peut être communiqué à un tiers sans notre autorisation.</p>				

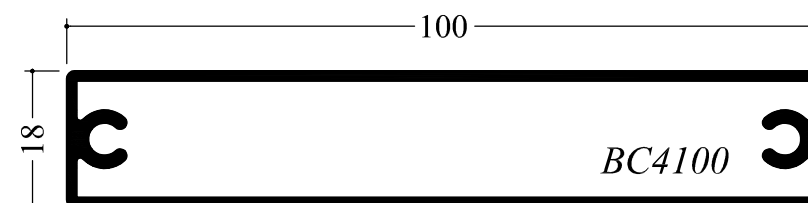
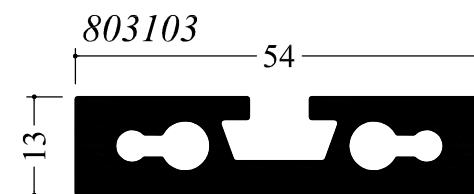
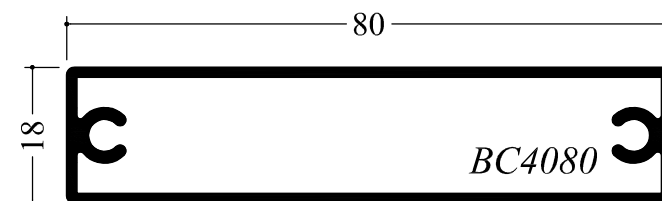
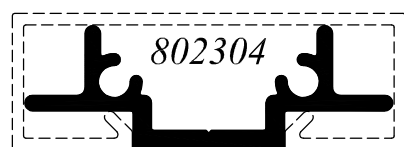
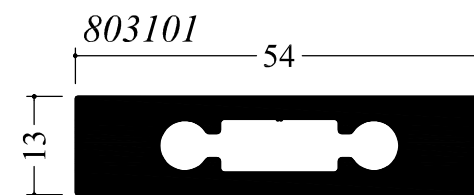
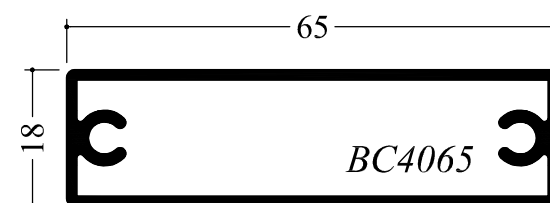
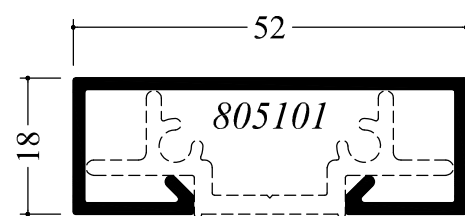
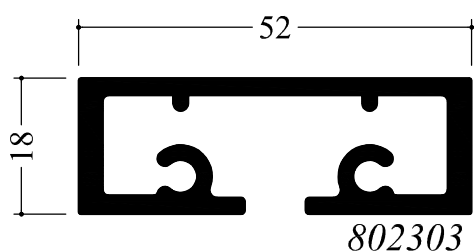
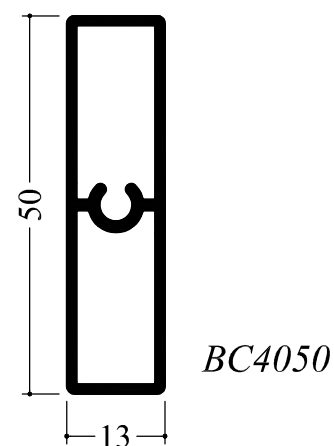
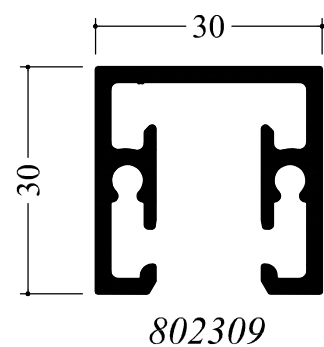
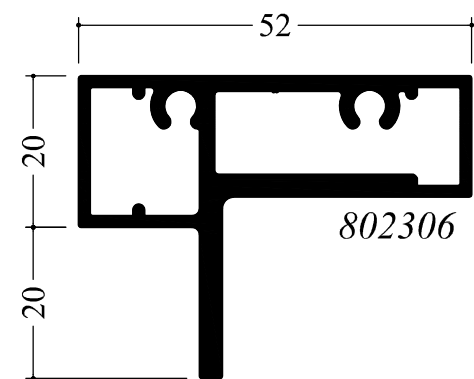
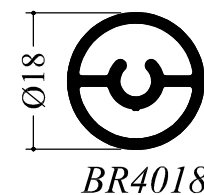
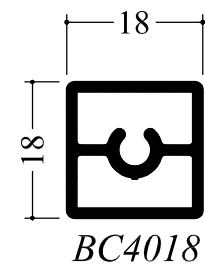
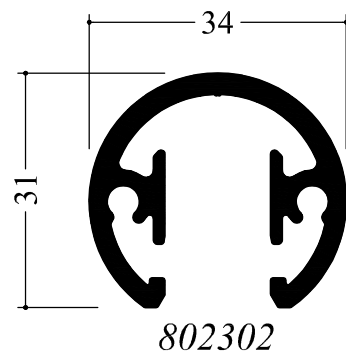
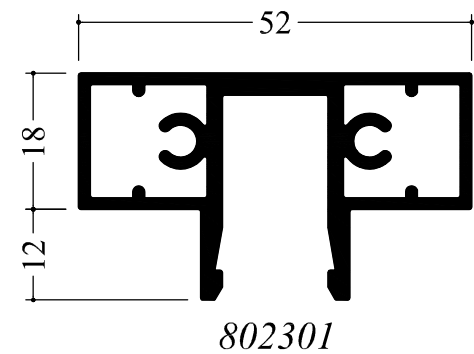
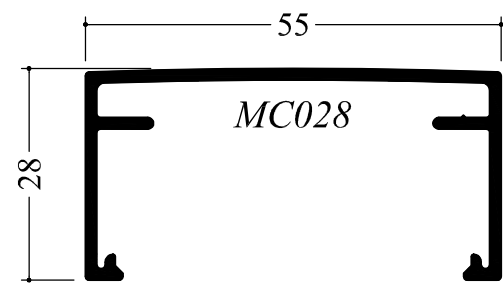

MC028

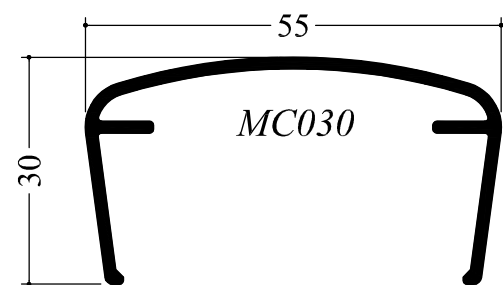

MC030

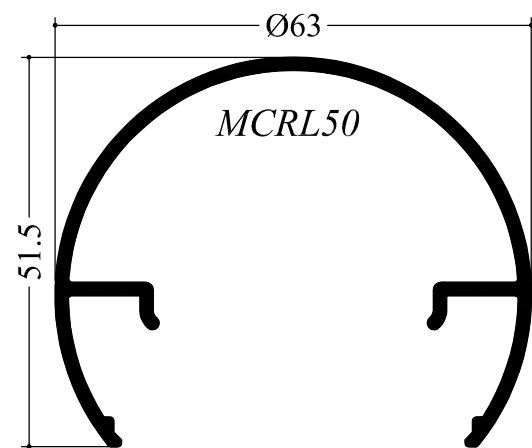

MCRL50

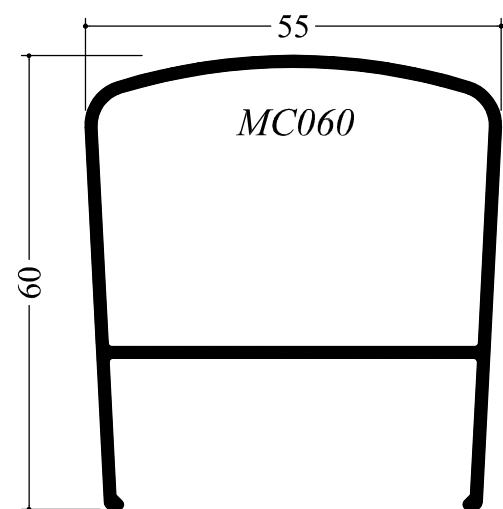

MC060

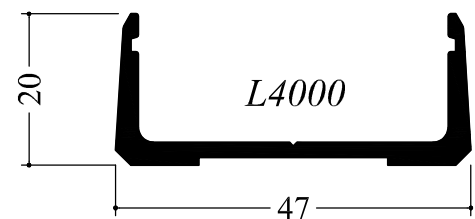

L4000

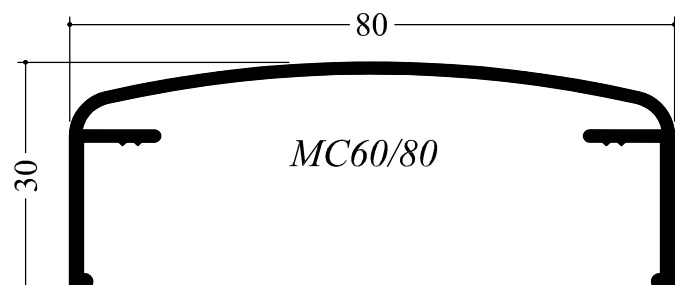

MC60/80

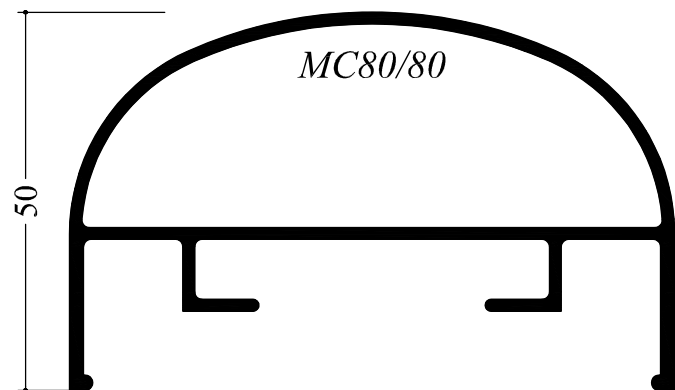

MC80/80

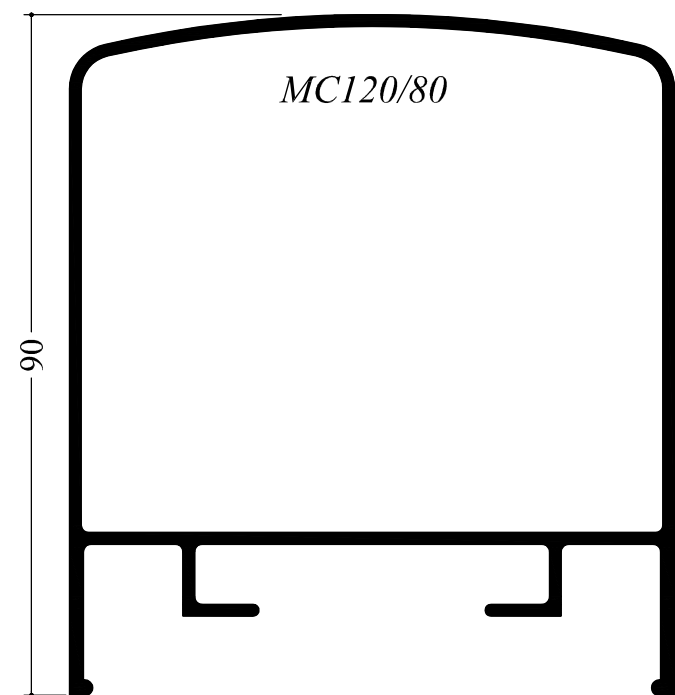

MC120/80

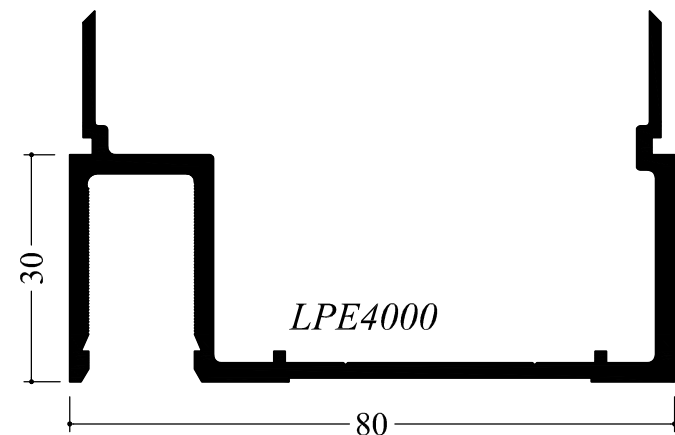

LPE4000

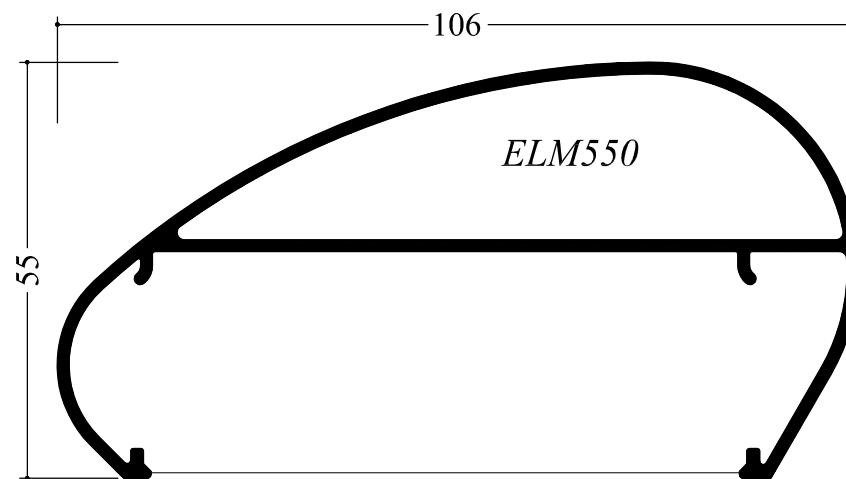

ELM550

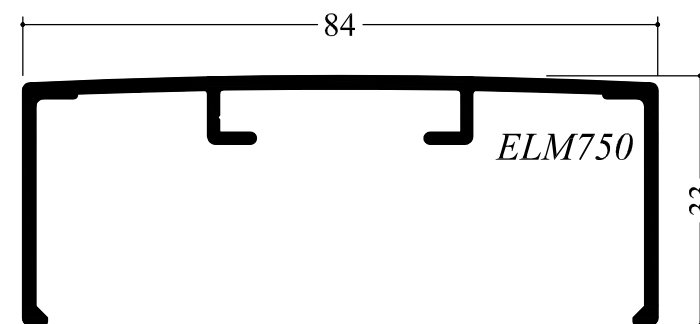

ELM750

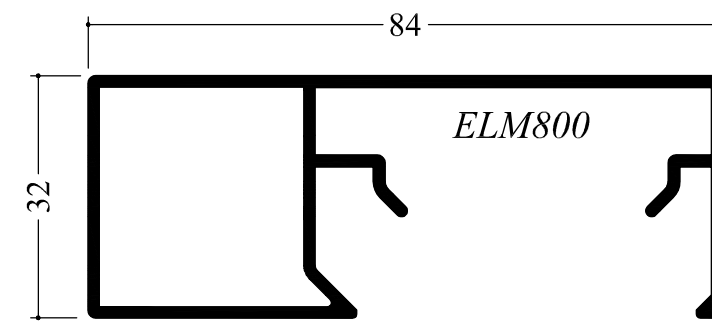

ELM800

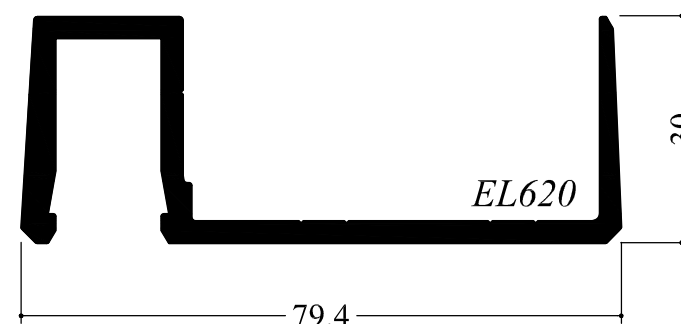

EL620

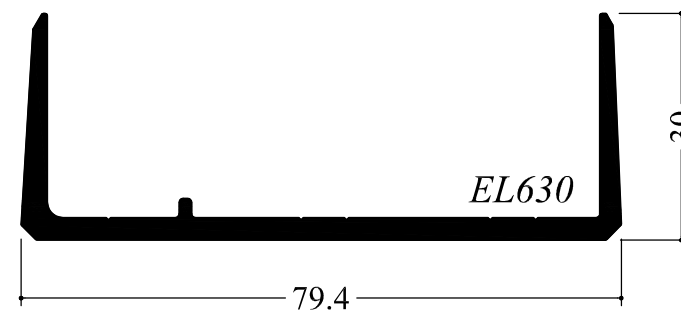

EL630

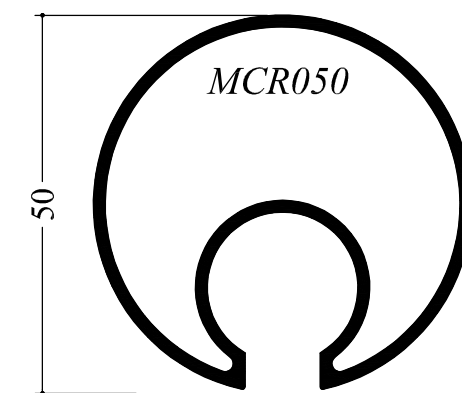

MCR050

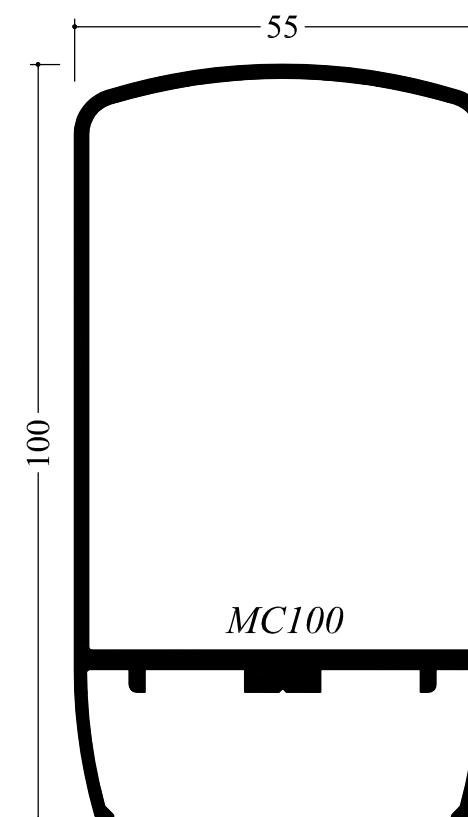

MC100

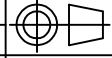
<b>BUGAL</b> Z.I. La Croix Rouge - 44260 MALVILLE Tel: 02 40 57 00 41 Fax: 02 40 57 06 75	DOSSIER	Profils	INDICE	E	 Profils PAGE 3/6 Ce plan est la propriété exclusive de la Sté BUGAL, et ne peut être communiqué à un tiers sans notre autorisation.
	PIECE/PROFIL		DATE	20/06/2016	
	DESIGNATION		ECHELLE	1/1	
	MATIERE	ALUMINIUM	PROJETEUR	S. PEDRONO	

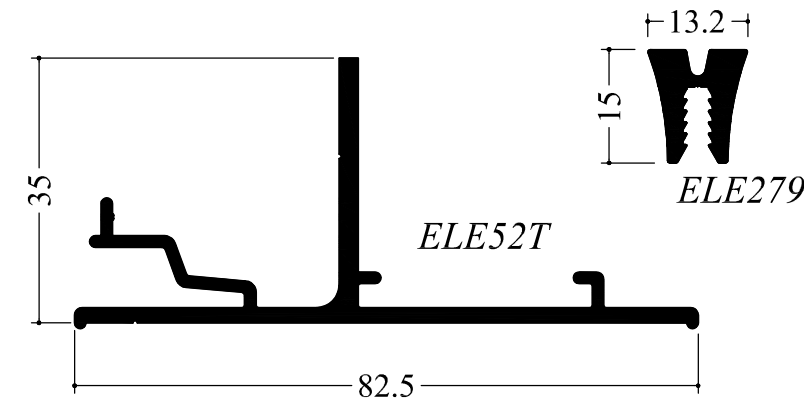
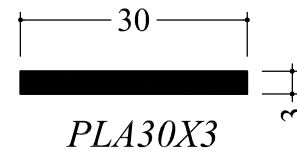
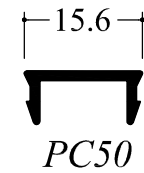
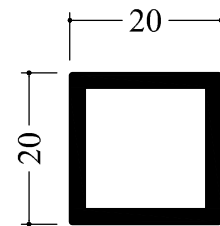
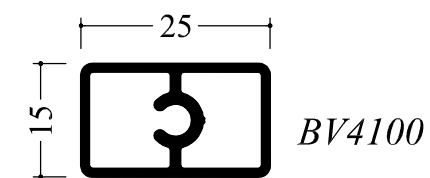
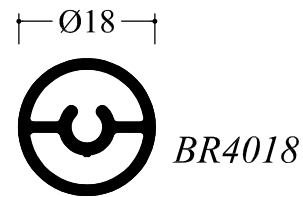
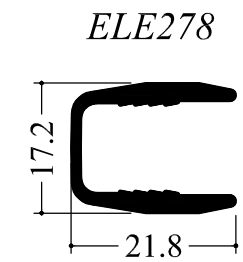
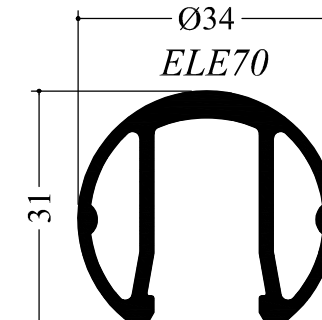
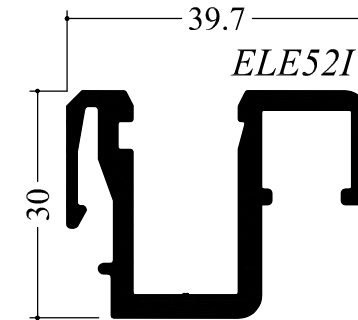
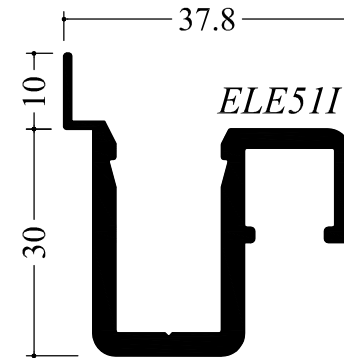
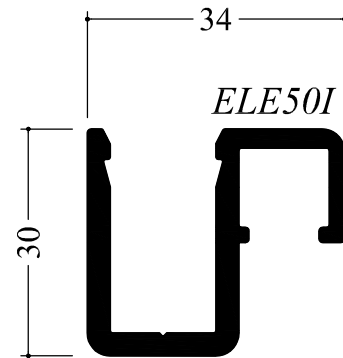
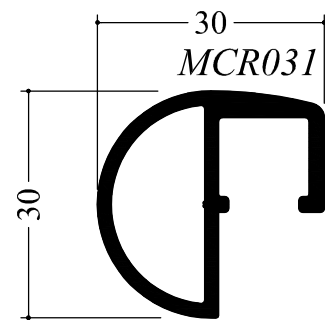
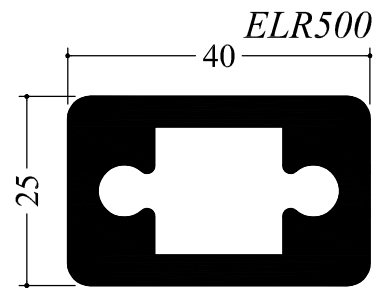
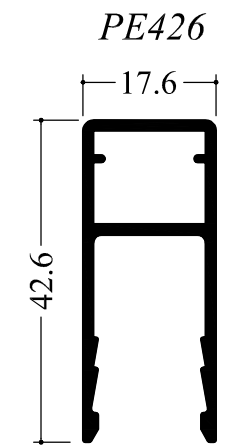
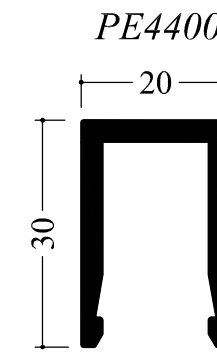
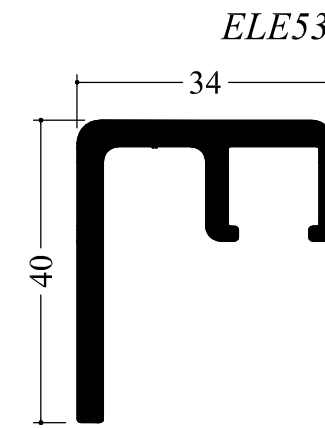
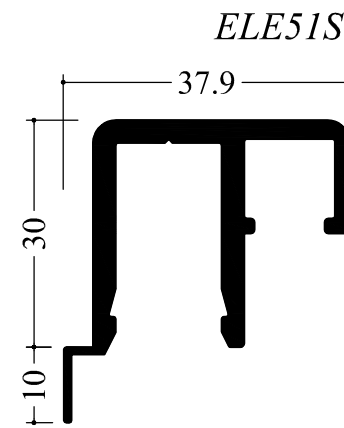
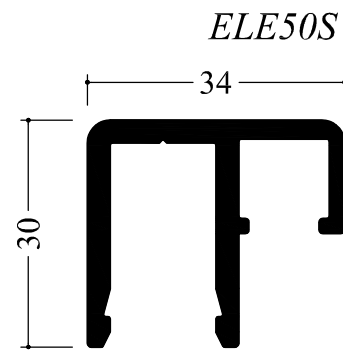
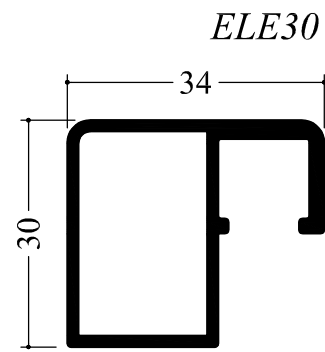
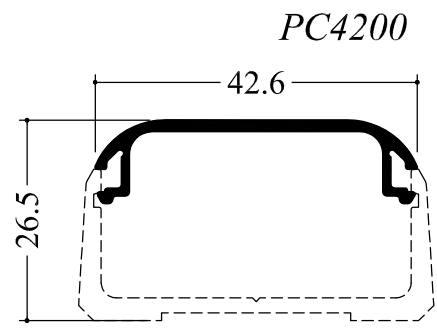

*Pour panneaux épaisseur de 2 à 4 mm*

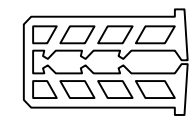

*JE5025*

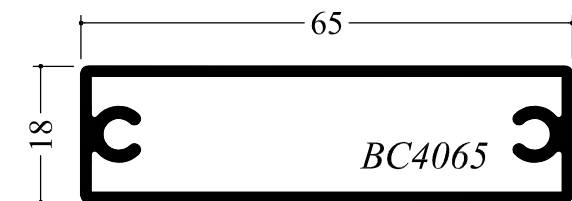

*Pour panneaux épaisseur de 2 à 4 mm*

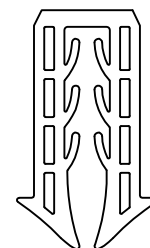

*JE5002*

*Pour panneaux épaisseur de 5 à 7 mm*

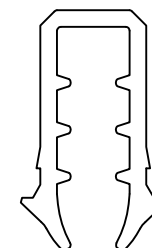

*JE5006*

*Pour panneaux épaisseur de 8 à 9 mm*

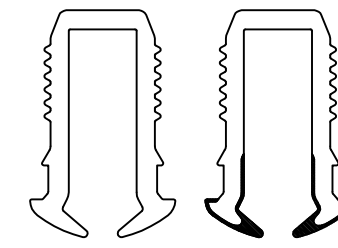

*JE5008 JE5008G*

*Pour panneaux épaisseur de 10 à 11 mm*

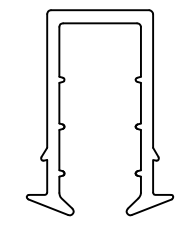

*JE5010*

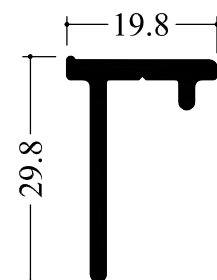
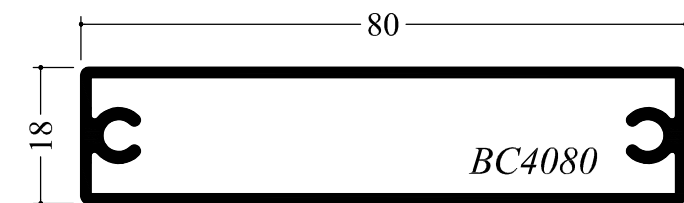

*ELE20*

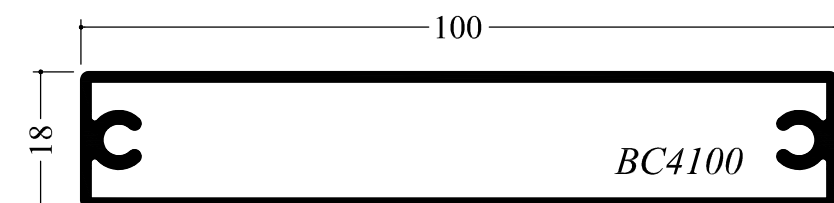

<b>BUGAL</b> <small>Z.I. La Croix Rouge - 44260 MALVILLE          Tel: 02 40 57 00 41 Fax: 02 40 57 06 75</small>	DOSSIER	Profils	INDICE	E	Profils PAGE 4/6 Ce plan est la propriété exclusive de la Sté BUGAL, et ne peut être communiqué à un tiers sans notre autorisation.
	PIECE/PROFIL		DATE	20/06/2016	
	DESIGNATION		ECHELLE	1/1	
	MATIERE	ALUMINIUM	PROJETEUR	S. PEDRONO	

*BARREAUDAL*

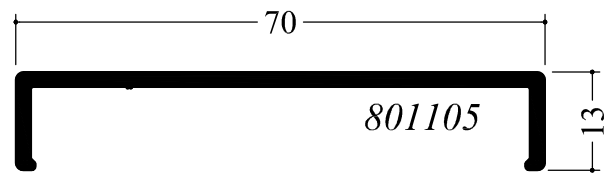

801105

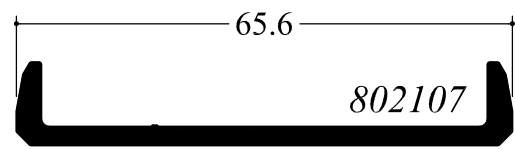

802107

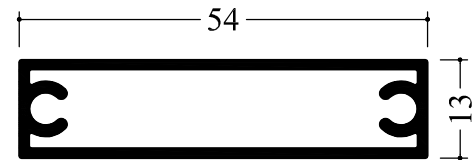

BC4054

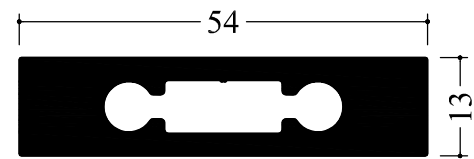

803101

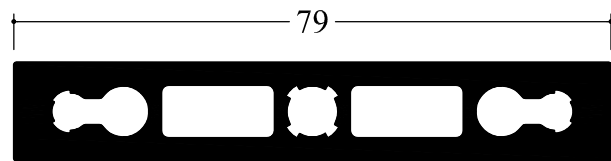

803102

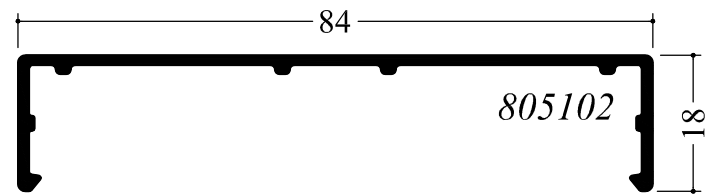

805102

*OXYTAL FILANT*

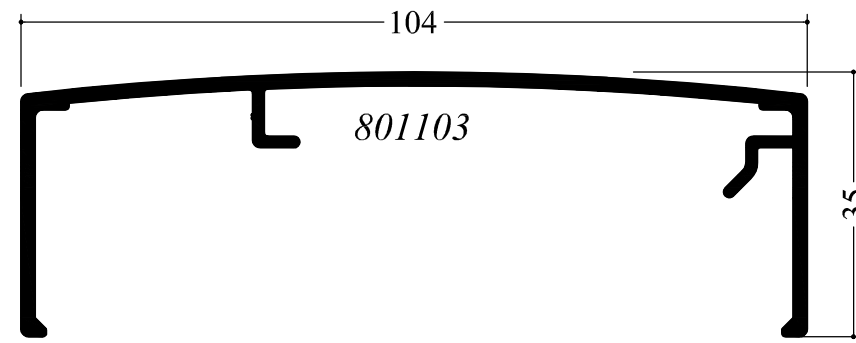

801103

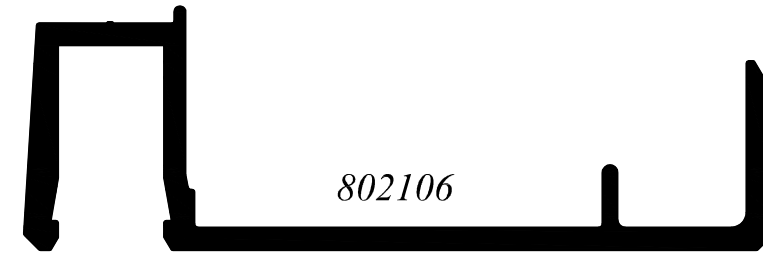

802106

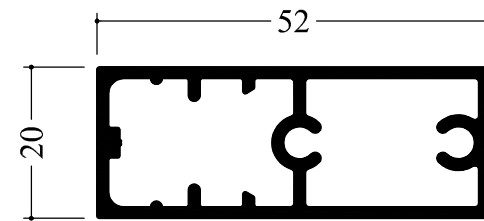

802207

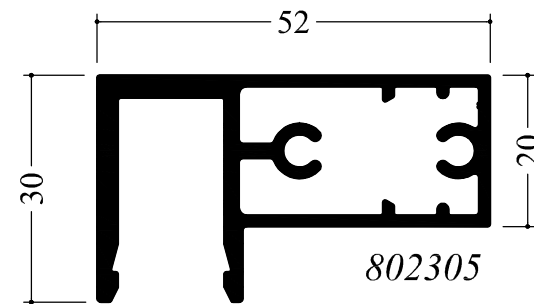

802305

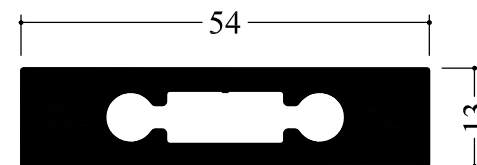

803101

*SEPARATIFS*

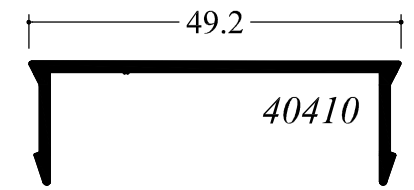

40410

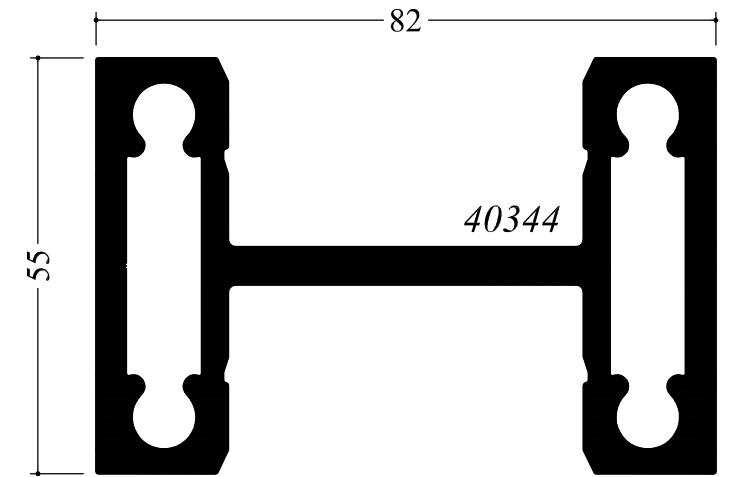

40344

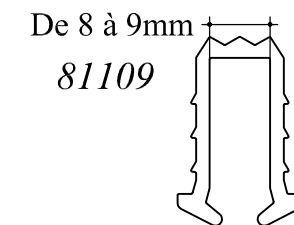

De 8 à 9mm  
81109

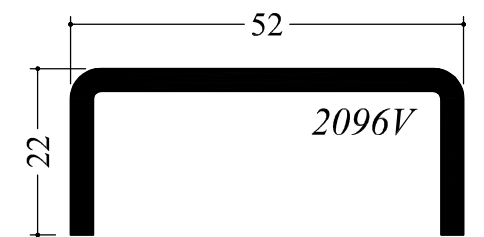

2096V

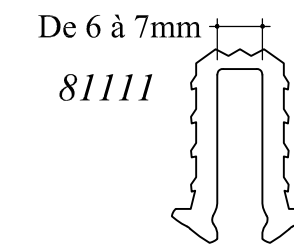

De 6 à 7mm  
81111

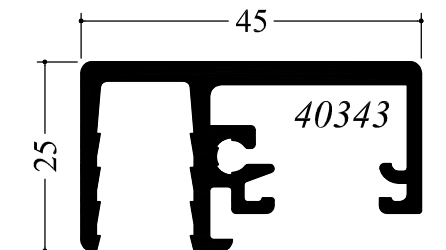

40343

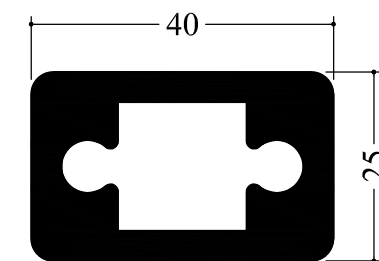

ELR500

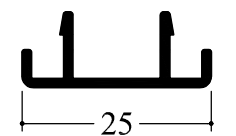

40409

<b>BUGAL</b> Z.I. La Croix Rouge - 44260 MALVILLE Tel: 02 40 57 00 41 Fax: 02 40 57 06 75	DOSSIER	Profils	INDICE	E	 Profils PAGE 5/6 Ce plan est la propriété exclusive de la Sté BUGAL, et ne peut être communiqué à un tiers sans notre autorisation.
	PIECE/PROFIL		DATE	20/06/2016	
	DESIGNATION		ECHELLE	1/1	
	MATIERE	ALUMINIUM	PROJETEUR	S. PEDRONO	

*GARDE-TOIT*

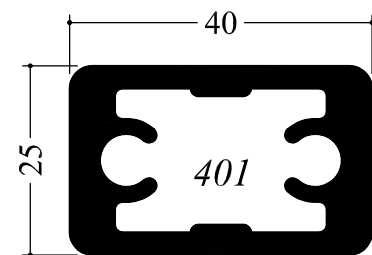
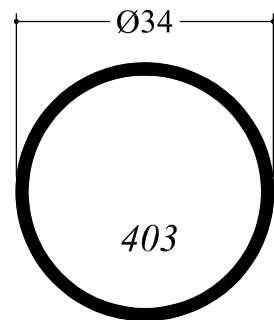
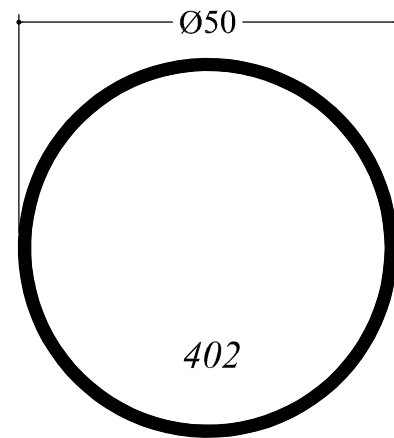

*DIVERS  
(lisse claustra  
coulissant)*

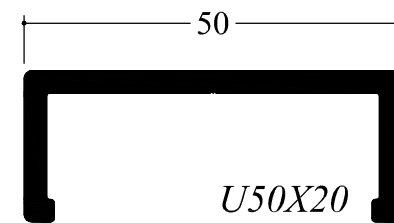
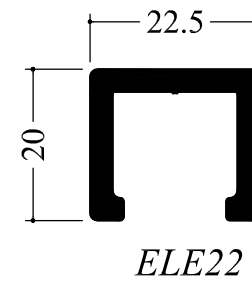
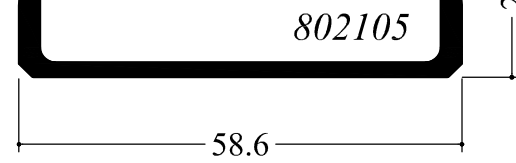

*GRAND LARGE-RAIDISSEUR UNIQUE*

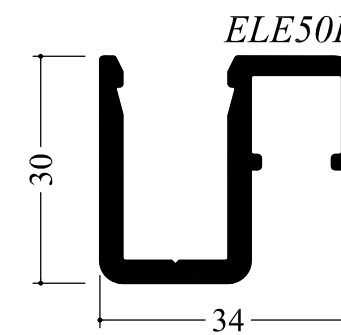
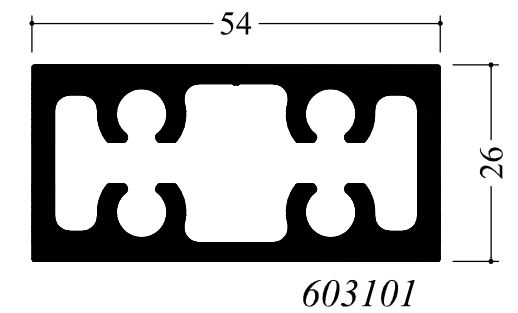
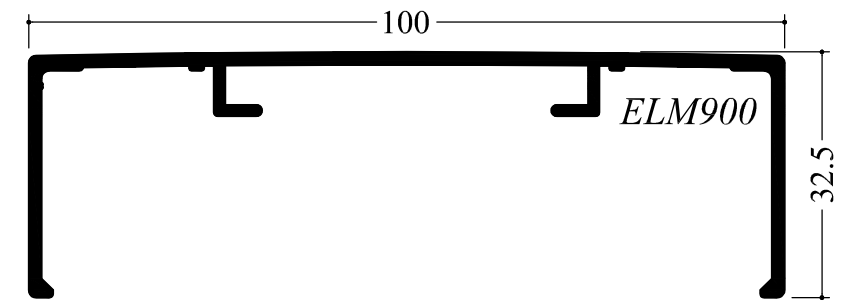

<p>Z.I. La Croix Rouge - 44260 MALVILLE Tel: 02 40 57 00 41 Fax: 02 40 57 06 75</p>	DOSSIER	Profils	INDICE	E	<p>Profils PAGE 6/6</p>
	PIECE/PROFIL		DATE	20/06/216	
	DESIGNATION		ECHELLE	1/1	
	MATIERE	ALUMINIUM	PROJETEUR	S. PEDRONO	
	Ce plan est la propriété exclusive de la Sté BUGAL, et ne peut être communiqué à un tiers sans notre autorisation.				